



# Price guide

**Advertising Mail (including Sustainable),  
Business Mail, Publishing Mail, Subscription Mail,  
Door to Door, Response Services and  
Inbound Mail Services**

March 2019

# Helping your business thrive and prosper

Royal Mail is the UK's designated Universal Postal Service Provider, supporting customers, businesses and communities across the country. We are the only company that has the capability to deliver a 'one-price-goes-anywhere', six-days-a-week service on a range of letters and parcels to more than 29 million addresses across the UK.

## Online Price Calculator

Use our online price calculator to find the best options for your mailing. There's also a downloadable excel version.

[royalmailtechnical.com/parcelpricecalculator](http://royalmailtechnical.com/parcelpricecalculator)

For other prices such as stamps, franking, parcels and international please visit:  
[royalmail.com/prices2019](http://royalmail.com/prices2019)

Although correct at the time this price guide was produced (November 2018), postal prices, fees and other conditions are subject to revision from time to time and services may need to be added or withdrawn.

Up-to-date information may be obtained by visiting [royalmail.com](http://royalmail.com)

# Contents

<b>Marketing Services</b>	<b>2</b>
<b>General Correspondence Products</b>	<b>3</b>
<b>Your mailing options</b>	<b>4</b>
<b>Know your formats</b>	<b>6</b>
<b>Advertising Mail</b>	
Royal Mail Advertising Mail®	7
Sustainable® Advertising Mail	13
<b>Door to Door</b>	
Royal Mail Door to Door®	15
<b>Business Mail</b>	
Business Mail 1st Class	17
Royal Mail Business Mail®	17
<b>Publishing Mail</b>	
Royal Mail Publishing Mail®	22
<b>Subscription Mail</b>	
23	
<b>Response Services</b>	
Business Reply Plus	24
Freepost Standard	24
Freepost NAME	24
Licence Fees	25
Admail	25
<b>Inbound Mail Services</b>	
Selectapost	26
Pre-sorted Delivery	26
Early Collect	26
Early Extraction	26
<b>Adjustment Charges</b>	
<b>27</b>	

# Marketing Services

## Royal Mail Advertising Mail®

Provides flexibility and savings on your direct mail and marketing campaigns.

It is already building many best-known brands' relationships with customers. With direct marketing campaigns delivering return on investment like never before, it's time to make it really work for you.

The right choice for your business if you:

- want a reliable medium that enables you to speak directly to customers and measure the effect
- need a service that is ideal for retaining existing customers, as well as acquiring new ones
- are sending over 1,000 Letters or Parcels or 250 Large Letters per day
- can meet our criteria for mail that is 100% advertising content.

To find out more go to

[royalmail.com/advertising-mail](http://royalmail.com/advertising-mail)

## Sustainable® Advertising Mail

Enables you to reach customers through direct mail, with a focus on the environment.

With Sustainable® Advertising Mail you can keep your green credentials intact. Make the most of this highly versatile and targeted medium, and save money too.

The right choice for your business if you:

- are using direct mail and want your mailings to have a low environmental impact
- can meet the Entry or Intermediate level specifications for Sustainable® Advertising Mail and so qualify for savings on Advertising Mail
- are posting at least 4,000 Letters or 1,000 Large Letters per day.

You can customise Sustainable® Advertising Mail to meet your needs by choosing from the options on pages 4-5.

To find out more go to

[royalmail.com/sustainable-advertising-mail](http://royalmail.com/sustainable-advertising-mail)

## Royal Mail Door to Door®

Royal Mail Door to Door® is our unaddressed leaflet distribution service. Delivered by our trusted network of delivery post people, only Door to Door offers you:

- access to all 29 million UK addresses with prices from just 5p per item
- the flexibility to deliver leaflets, catalogues, samples and more
- free planning and targeting of your distribution to ensure your message reaches the right people
- creative and design support to maximise the impact of your items
- exclusivity – your item won't be sent out with any that have a competing message with yours
- a new Collection Service – meaning we'll come and collect your items from you
- flexible payment options – via account or via debit/credit card.

To find out more go to [royalmail.com/doortodoor](http://royalmail.com/doortodoor)

## Royal Mail Subscription Mail®

Subscription Mail is our new subscription magazine service, where items posted contain 30% or more editorial content. This new service launches on **2 January 2019**.

We consulted the sector and customers told us they need certainty to grow their subscriptions. Subscription Mail offers up to 12-months price certainty so that customers can plan ahead and invest in launching new titles.

The service is a Royal Mail Mailmark® specification so customers can benefit from significant savings.

# General Correspondence Products

## Business Mail 1st Class and Royal Mail Business Mail®

Is the perfect solution for your general business correspondence and transactional mail, such as bills, statements or invoices.

Business Mail 1st Class is the right option for businesses or organisations looking to send critical or time-sensitive mail quickly – and get a response just as fast. For items that do not require urgent delivery, Business Mail 2nd Class is the perfect solution.

The right choice for your business if you:

- are sending out general correspondence and transactional mail
- want to reach your customers and build trust and relationships
- want to earn savings for the volume of mail you send or for doing some preparation of your mail.

You can customise Business Mail 1st Class and Business Mail to meet your needs by choosing from the options on pages 4-5.

To find out more go to

[royalmail.com/business-mail](http://royalmail.com/business-mail)

If you do not want to take up any of the special options detailed in these pages, simply hand your mail over to us and we will do the rest.

## New Unsorted Barcodes

We have started to phase out some of our unsorted options. It is important to use one of the barcoded options to get the best prices. Account customers can save 3p by printing a simple barcode.

To find out more go to

[royalmail.com/barcodesavings](http://royalmail.com/barcodesavings)

## Royal Mail Publishing Mail®

Is our specialist mailing service for publishers and distributors of magazines, journals and newsletters.

The right choice for your business if you:

- publish magazines, newsletters, periodicals or journals with at least one-sixth editorial content
- distribute a minimum of 1,000 items at least twice a year – there is no limit on the amount you can send
- want to earn savings for the volume of mail you send or for doing some preparation of your mail.

You can customise Publishing Mail to meet your needs by choosing from the options on pages 4-5.

To find out more go to

[royalmail.com/publishing-mail](http://royalmail.com/publishing-mail)

## Response Services

Our Response Services enable businesses and consumers to react to direct marketing, magazine inserts, press advertisements, voting communications and surveys through an item of mail; paid by you.

You can use them to great effect for electoral communications, market research and surveys too. It's all done with a dedicated item of mail paid through your account with Royal Mail.

Choose Business Reply Standard for:

- replies by 1st or 2nd Class
- can be personalised with your branding and logo.

Choose FREEPOST NAME for:

- handwritten or printed options
- respondent only writes the FREEPOST NAME – no full postal address required.

To find out more go to

[royalmail.com/standardresponseservices](http://royalmail.com/standardresponseservices) or [royalmail.com/freepostname](http://royalmail.com/freepostname)

# Your mailing options

For businesses and organisations which use mail as an integral part of their communications plans, Royal Mail have a number of options available for you to choose from. The final price for your mailing will depend on a number of choices that you make, and this price guide is intended to give you an overview of the options. Should you need any further details please see the appropriate product guide at [royalmail.com](http://royalmail.com) or call **08457 950 950\***.

## What is the content of your mailing?

### Advertising Mail

Mailings which comprise a largely uniform message to all addressees, with the purpose of promoting the sale or use of products or services, or to encourage contribution to, or support of a cause.

### Publishing Mail

A service for periodicals such as newsletters, journals and magazines (but not brochures, catalogues, directories and exhibition guides). Before customers can use the service we need to verify that items meet our qualifying criteria. At least one-sixth of the periodical must be editorial content.

### Business Mail

Typically contain general correspondence and items of a personalised nature for transactional, contractual or relationship purposes. Generally they are for mailings that do not qualify for Advertising Mail, Sustainable Advertising Mail or Publishing Mail. Goods cannot be sent in Business Mail – please use one of our Parcels products.

## How much does it weigh?

Typically we have a single price for 0-100g, another for 101-250g, then above 250g you pay for each additional gram.

With the parcel format (only available with Advertising Mail and Publishing Mail) the weight band is 0-750g then 751-1000g. Above 1000g you pay for each additional gram.

## How quickly do you want it delivered?

<b>1st Class</b>	The working day after collection
<b>2nd Class</b>	2 working days after collection
<b>Economy</b>	4 working days after collection

## Are you able to pre-sort the mailing into separate containers, depending on the destination?

We then pass on the cost saving to you. Most of our customers who use this facility use the services of a Mailing House to realise this potential. Should you need any support in making this happen please do call us on **08457 950 950\***.

**Unsorted** is where you just give us the mail as it is.

**Low Sort** is where we ask you to sort to Mail Centre level (c 80 selections) for mail that can be processed through our letter sorting equipment (our lowest cost way of processing mail).

**High Sort** requires a deeper level of sortation as it separates mail for each Delivery Office (c 1500 selections).

# Your mailing options

## Can the items be processed by our Sortation and Sequencing equipment? (Machine Readability)

**MailMark®** is the new style barcode which is able to direct and track individual items through the network up to the point where they are ready for delivery.

**OCR** - even just applying the right font, and making sure that certain areas of the envelope are clear from text or artwork, can help us use Optical Character Recognition.

**Address Quality** - items that are carefully and accurately addressed will give better performance and help achieve lower prices.

Again, many customers make use of third party providers to realise the savings that are achievable here. Give us a call and we can point you in the right direction.

## What containers are you presenting the mail in?

We have migrated much of our internal movement of mail into trays rather than bags to drive efficiency, and now offer customers for our pre-sorted products a preferential rate if you can do the same. Trays protect your mail from damage.

## Does your mail achieve the best environmental standards - Sustainable Advertising Mail?

For customers who use Advertising Mail, we offer an additional discount if you are able to meet our highest standard of production processes, address quality and recycling awareness.

## What is your mailing volume?

If your daily volumes (per speed and format) reach certain threshold levels you will get additional discounts.

## How do you access these services?

Access to the services in this price guide is via a Royal Mail Online Business Account, which is our online ordering and invoicing system. It allows you to order mail services and manage your Royal Mail invoices quickly and simply in one place. For more information go to: [royalmail.com/oba](http://royalmail.com/oba)

\*Calls cost 5p per minute plus your telephone company's network access charge.

# Know your formats

Here are the formats we use to work out the postage. Each format has its own size and weight limits. The illustrations below will help you check the format of your item.

## Advertising Mail & Business Mail\*

### Letter Up to 100g

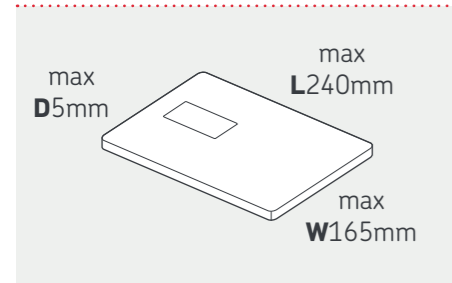

### Large Letter Up to 750g

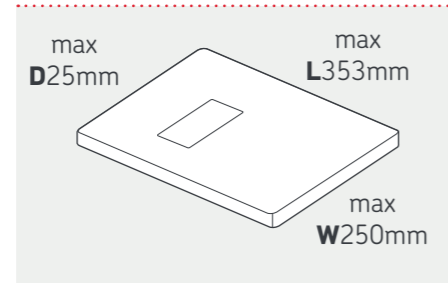

\*There is no Parcel option in Business Mail and goods are not permitted in Business Mail Large Letters. For information on Parcels services please visit [royalmail.com/parcels](http://royalmail.com/parcels)

## Publishing Mail

### Large Letter Up to 750g

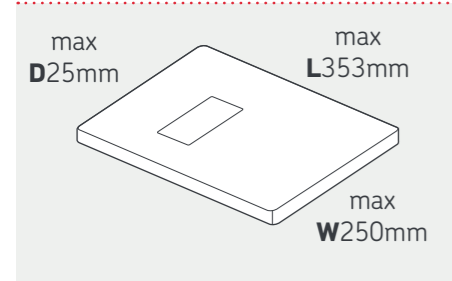

### Large Letter – machine readable Up to 750g

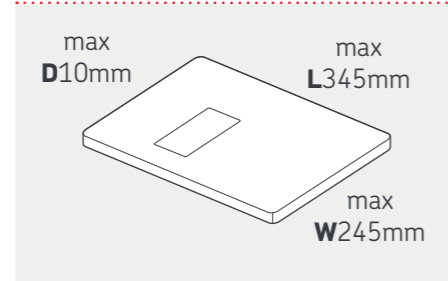

## Response Services

### Letter Up to 100g

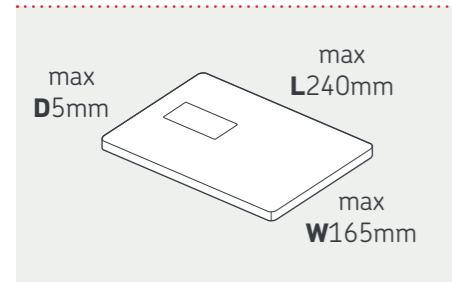

### Large Letter Up to 750g

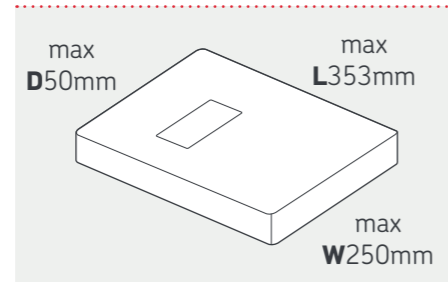

## Subscription Mail

### Large Letter – machine readable Up to 750g

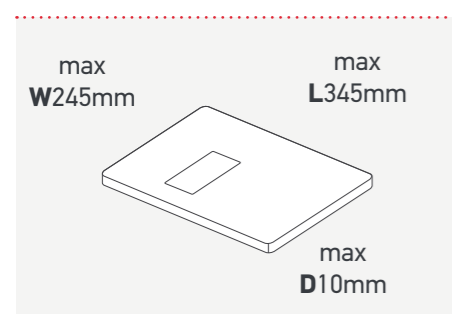

### Large Letter – machine readable Up to 750g

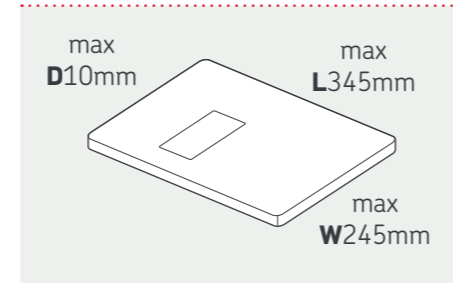

## Door to Door

### Items Up to 200g\*

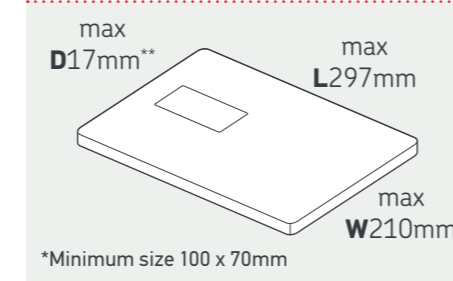

\*Minimum size 100 x 70mm

Bundles to weigh less than **6.4kg**. Boxes to weigh less than **10kg**. In each box – every item to weigh the same and be made from the same paper weight.

We can check your item when you send us a sample, and if you want to talk anything through with the team you can call: **0345 266 0858**.

\*\*If your item is more than 5mm thick please contact the Door to Door team on 0345 266 0858 for advice.

# Advertising Mail

## Standard unsorted options

### Letter

Delivery Speed	Option	Product Code	Weight up to and including	Number of items per sales order <sup>†</sup>			
				1,000-2,499	2,500-9,999	10,000-24,999	25,000+
1st Class	Standard	CLN	100g	61.8p	60.6p	59.3p	58.1p
	Account <sup>††</sup>	UNC	100g	58.4p	57.2p	56.0p	54.9p
2nd Class	Standard	CLN	100g	37.3p	36.6p	35.8p	35.0p
	Account <sup>††</sup>	UND	100g	36.3p	35.6p	34.9p	34.1p

Prices in this table exclude VAT, which is charged at the standard rate.

Prices in this table exclude the Mailing Standards Levy of 0.2% which is not subject to VAT.

Further details of the Mailing Standards Levy can be found in the specific terms relating to Advertising Mail.

<sup>†</sup>In order to qualify for a price based on number of items, items must be of the same service, class and format, and be contained on a single sales order.

Mailings of less than 1,000 items may be refused or charged at a higher rate.

<sup>††</sup>A Barcode is required for the Account options. For further information visit [royalmail.com/barcodesavings](http://royalmail.com/barcodesavings)

## Highly Machine readable unsorted options

### Letter

Delivery Speed	Option	Product Code	Weight up to and including	Number of items per sales order <sup>†</sup>			
				1,000-2,499	2,500-9,999	10,000-24,999	25,000+
1st Class	Advanced	UNK	100g	49.1p	48.1p	47.1p	46.1p
	Mailmark	EBT	100g	47.8p	46.8p	45.8p	44.8p
	OCR	CLF	100g	50.9p	49.8p	48.8p	47.7p
2nd Class	Advanced	UNL	100g	29.2p	28.6p	28.0p	27.4p
	Mailmark	EBU	100g	28.6p	28.0p	27.4p	26.8p
	OCR	CLH	100g	30.0p	29.3p	28.7p	28.1p

Prices in this table exclude VAT, which is charged at the standard rate.

Prices in this table exclude the Mailing Standards Levy of 0.2% which is not subject to VAT.

Further details of the Mailing Standards Levy can be found in the specific terms relating to Advertising Mail.

<sup>†</sup>In order to qualify for a price based on number of items, items must be of the same service, class and format, and be contained on a single sales order.

Mailings of less than 1,000 items may be refused or charged at a higher rate.

# Advertising Mail

## Low Sort and High Sort options

### Letter

Delivery Speed	Option	Product Code	Weight up to and including	Number of items per day*				
				4,000-19,999	20,000-39,999	40,000-79,999	80,000-119,999	120,000+
<b>1st Class</b>	Low-Sort Mailmark	EBD	100g	45.3p	44.4p	43.2p	42.6p	42.2p
	Low-Sort OCR	AUR	100g	47.2p	46.3p	45.1p	44.5p	44.1p
	High Sort Direct	AUX	100g	56.0p	55.0p	53.8p	53.2p	52.7p
	High Sort Residue*	AUX	100g	57.5p	56.5p	55.9p	55.9p	55.6p
<b>2nd Class</b>	Low-Sort Mailmark	EBE	100g	22.5p	22.1p	21.5p	21.2p	21.0p
	Low-Sort OCR	AVN	100g	23.4p	22.9p	22.3p	22.1p	21.8p
	High Sort Direct	AV1	100g	26.9p	26.5p	25.9p	25.6p	25.3p
	High Sort Residue*	AV1	100g	27.6p	27.2p	26.9p	26.9p	26.7p
<b>Economy</b>	Low-Sort Mailmark	EBF	100g	20.2p	19.8p	19.3p	19.0p	18.8p
	Low-Sort OCR	AVU	100g	21.0p	20.6p	20.1p	19.8p	19.6p
	High Sort Direct	AV4	100g	23.1p	22.7p	22.2p	21.9p	21.7p
	High Sort Residue*	AV4	100g	23.7p	23.4p	23.3p	23.2p	23.2p

Prices in this table exclude VAT, which is charged at the standard rate.

Prices in this table exclude the Mailing Standards Levy of 0.2% which is not subject to VAT.

Further details of the Mailing Standards Levy can be found in the specific terms relating to Advertising Mail.

\*The price for Residue is based on the number of items per mailing, not per day.

Mailings of less than 4,000 items may be refused or charged at a higher rate.

**Tray savings:** For trayed mailings of Letters you can save 0.30p (ex VAT) per item from the prices in this table.

# Advertising Mail

## Catalogue option

### Letter

Delivery Speed	Option	Product Code	Weight up to and including	Number of items per day*				
				4,000-19,999	20,000-39,999	40,000-79,999	80,000-119,999	120,000+
<b>Economy</b>	High Sort Direct	AM3	100g	23.1p	22.7p	22.2p	21.9p	21.7p
		AM3	110g	23.7p	23.3p	22.8p	22.5p	22.3p
		AM3	120g	25.0p	24.6p	24.1p	23.8p	23.6p
		AM3	130g	26.3p	25.9p	25.3p	25.0p	24.8p
		AM3	140g	27.5p	27.1p	26.5p	26.2p	25.9p
		AM3	150g	28.8p	28.3p	27.7p	27.4p	27.1p
	High Sort Residue*	AM3	100g	23.7p	23.4p	23.3p	23.2p	23.2p
		AM3	150g	43.8p	43.4p	43.2p	42.9p	42.9p

### Large Letter

Delivery Speed	Option	Product Code	Weight up to and including	Number of items per day*				
				1,000-9,999	10,000-19,999	20,000-39,999	40,000-59,999	60,000+
<b>Economy</b>	High Sort Direct	AM3	100g	29.1p	28.6p	27.9p	27.6p	27.3p
		AM3	110g	30.0p	29.5p	28.8p	28.5p	28.2p
		AM3	120g	31.8p	31.3p	30.5p	30.2p	29.9p
		AM3	130g	33.6p	33.0p	32.2p	31.8p	31.5p
		AM3	140g	35.4p	34.8p	34.0p	33.6p	33.2p
		AM3	150g	36.9p	36.2p	35.4p	35.0p	34.6p
	High Sort Residue*	AM3	250g	39.3p	38.6p	37.7p	37.3p	36.9p
		AM3	100g	32.4p	32.3p	32.1p	32.1p	32.1p
		AM3	150g	43.8p	43.6p	43.4p	43.4p	43.4p
		AM3	250g	43.8p	43.6p	43.4p	43.4p	43.4p

For details of Large Letters over 250g see the Advertising Mail rate card.

Prices in this table exclude VAT, which is charged at the standard rate.

Prices in this table exclude the Mailing Standards Levy of 0.2% which is not subject to VAT.

Further details of the Mailing Standards Levy can be found in the specific terms relating to Advertising Mail.

\*The price for Residue is based on the number of items per mailing, not per day.

Mailings of less than 1,000 Large Letters or 4,000 Letters may be refused or charged at a higher rate.

**Tray savings:** For trayed mailings you can save 0.30p for Letters and 0.90p for Large Letters (ex VAT) per item from the prices in this table.

# Advertising Mail

## Standard unsorted options

### Large Letter

Delivery Speed	Option	Product Code	Weight up to and including	Number of items per sales order <sup>†</sup>			
				250-749	750-1,999	2,000-4,999	5,000+
1st Class	Standard	CLN	100g	94.8p	92.8p	90.9p	89.0p
			250g	131.0p	128.3p	125.7p	123.0p
			500g	166.5p	163.1p	159.7p	156.3p
			750g	233.4p	228.7p	224.0p	219.2p
	Account <sup>††</sup>	UNC	100g	92.6p	90.7p	88.8p	87.0p
			250g	128.1p	125.5p	122.9p	120.3p
			500g	162.5p	159.2p	155.9p	152.6p
			750g	229.5p	224.8p	220.2p	215.5p
2nd Class	Standard	CLN	100g	65.6p	64.3p	62.9p	61.6p
			250g	93.6p	91.7p	89.8p	87.9p
			500g	121.2p	118.7p	116.2p	113.8p
			750g	172.4p	168.9p	165.4p	161.9p
	Account <sup>††</sup>	UND	100g	63.0p	61.8p	60.5p	59.2p
			250g	90.6p	88.8p	86.9p	85.1p
			500g	119.9p	117.4p	115.0p	112.6p
			750g	171.6p	168.1p	164.6p	161.1p

Prices in this table exclude VAT, which is charged at the standard rate.

Prices in this table exclude the Mailing Standards Levy of 0.2% which is not subject to VAT.

Further details of the Mailing Standards Levy can be found in the specific terms relating to Advertising Mail.

<sup>†</sup>In order to qualify for a price based on number of items, items must be of the same service, class and format, and be contained on a single sales order.

Mailings of less than 250 items may be refused or charged at a higher rate.

<sup>††</sup>Barcode savings. A barcode is required for the Account options. For further information visit [royalmail.com/barcodesavings](http://royalmail.com/barcodesavings)

# Advertising Mail

## Highly machinable unsorted options

### Large Letter

Delivery Speed	Option	Product Code	Weight up to and including	Number of items per sales order <sup>†</sup>					
				1-249	250-749	750-1,999	2,000-4,999	5,000+	
1st Class	Mailmark	EBT	100g	94.0p	81.1p	79.3p	77.6p	75.9p	
			250g	130.0p	112.1p	109.6p	107.4p	105.0p	
			500g	172.0p	148.3p	145.1p	142.1p	138.9p	
			750g	245.0p	211.3p	206.6p	202.3p	197.8p	
	Advanced	UNK	100g	94.0p	83.4p	81.4p	79.8p	78.0p	
			250g	130.0p	115.3p	112.6p	110.4p	107.9p	
			500g	168.0p	149.0p	145.6p	142.6p	139.4p	
			750g	239.0p	211.9p	207.1p	202.9p	198.3p	
	OCR	CLF	100g	n/a	85.5p	83.6p	81.9p	80.0p	
			250g	n/a	121.8p	119.2p	116.7p	114.1p	
			500g	n/a	158.2p	154.7p	151.5p	148.1p	
			750g	n/a	224.0p	219.1p	214.5p	209.8p	
	2nd Class	Mailmark	EBU	100g	64.0p	58.9p	57.7p	56.5p	55.2p
				250g	92.0p	84.7p	82.9p	81.2p	79.4p
				500g	121.7p	112.1p	109.6p	107.4p	105.0p
				750g	174.2p	160.5p	156.9p	153.7p	150.2p
Advanced		UNL	100g	64.0p	62.6p	61.4p	60.1p	58.8p	
			250g	92.0p	90.1p	88.2p	86.4p	84.6p	
			500g	121.7p	119.1p	116.7p	114.3p	111.9p	
			750g	174.2p	170.5p	167.1p	163.6p	160.1p	
OCR		CLH	100g	n/a	64.0p	62.6p	61.3p	59.9p	
			250g	n/a	90.2p	88.2p	86.4p	84.5p	
			500g	n/a	117.6p	115.0p	112.6p	110.1p	
			750g	n/a	169.0p	165.3p	161.9p	158.2p	

Prices in this table exclude VAT, which is charged at the standard rate.

Prices in this table exclude the Mailing Standards Levy of 0.2% which is not subject to VAT.

Further details of the Mailing Standards Levy can be found in the specific terms relating to Advertising Mail.

<sup>†</sup>In order to qualify for a price based on number of items, items must be of the same service, class and format, and be contained on a single sales order.

Mailings of less than 250 OCR items may be refused or charged at a higher price.

**Tray savings:** For trayed mailings of Large Letters up to 10mm thick you can save 0.90p (ex VAT) per item from the prices in this table.

# Advertising Mail

## Sorted options

### Large Letter

Delivery Speed	Option	Product Code	Weight up to and including	Number of items per day*				
				1,000-9,999	10,000-19,999	20,000-39,999	40,000-59,999	60,000+
1st Class	Low-Sort Mailmark	EBD	100g	63.8p	62.7p	61.2p	60.5p	59.9p
			250g	71.9p	70.7p	69.0p	68.2p	67.5p
	Low-Sort OCR	AUR	100g	67.3p	66.6p	66.2p	65.8p	65.0p
			250g	76.3p	75.5p	75.1p	74.6p	73.8p
	High Sort Direct	AUX	100g	66.2p	65.1p	63.6p	62.8p	62.2p
			250g	74.8p	73.5p	71.8p	71.0p	70.3p
	High Sort Residue*	AUX	100g	73.9p	72.8p	72.0p	72.0p	71.6p
			250g	83.4p	82.1p	81.3p	81.3p	80.8p
2nd Class	Low-Sort Mailmark	EBE	100g	33.0p	32.4p	31.6p	31.2p	30.9p
			250g	44.1p	43.3p	42.3p	41.8p	41.4p
	Low-Sort OCR	AVN	100g	34.6p	34.2p	34.0p	33.8p	33.4p
			250g	46.3p	45.8p	45.5p	45.3p	44.7p
	High Sort Direct	AV1	100g	33.6p	33.1p	32.3p	31.9p	31.6p
			250g	45.2p	44.4p	43.4p	42.8p	42.4p
	High Sort Residue*	AV1	100g	37.5p	37.0p	36.6p	36.6p	36.4p
			250g	50.4p	49.6p	49.1p	49.1p	48.9p
Economy	Low-Sort Mailmark	EBF	100g	28.5p	28.0p	27.3p	27.0p	26.7p
			250g	38.4p	37.7p	36.8p	36.3p	36.0p
	Low-Sort OCR	AVU	100g	29.9p	29.6p	29.4p	29.3p	28.9p
			250g	40.4p	39.9p	39.7p	39.5p	39.0p
	High Sort Direct	AV4	100g	29.1p	28.6p	27.9p	27.6p	27.3p
			250g	39.3p	38.6p	37.7p	37.3p	36.9p
	High Sort Residue*	AV4	100g	32.4p	32.3p	32.1p	32.1p	32.1p
			250g	43.8p	43.6p	43.4p	43.4p	43.4p

For details of Large Letters over 250g and Parcels see the **Advertising Mail rate card**.

Prices in this table exclude VAT, which is charged at the standard rate.

Prices in this table exclude the Mailing Standards Levy of 0.2% which is not subject to VAT.

Further details of the Mailing Standards Levy can be found in the specific terms relating to Advertising Mail.

Mailings of less than 1,000 items may be refused or charged at a higher rate.

\*The price for Residue is based on the number of items per mailing, not per day.

**Tray savings:** For trayed mailings of Large Letters up to 10mm thick you can save 0.90p (ex VAT) per item from the prices in this table.

# Sustainable® Advertising Mail

Sustainable® Advertising Mail prices are determined on the appropriate Advertising Mail with High Sort options or Low Sort options price plus the Sustainable® Advertising Mail percentage discount as shown below:

The prices determined by this rate card are indicative. Prices after discount have been rounded and may not perfectly match the invoiced details.

**Table 1 – Entry Level pricing structure**

Delivery Speed	Format	Weight up to and including	Low Sort		High Sort	
			Mailmark	OCR	Direct	Residue
<b>1st Class</b>						
<b>Product Code</b>			<b>EBG</b>	<b>MXS</b>	<b>SPA</b>	<b>SPA</b>
	<b>Letter</b>	0-100g	2.90%	2.50%	1.20%	1.30%
	<b>Large Letter</b>	0-100g	3.00%	3.00%	2.25%	1.50%
	<b>Large Letter</b>	101-250g	2.20%	1.70%	2.50%	1.80%
	<b>Large Letter</b>	251-750g	2.50%	1.50%	2.25%	1.75%
<b>2nd Class</b>						
<b>Product Code</b>			<b>EBH</b>	<b>MXT</b>	<b>SPG</b>	<b>SPG</b>
	<b>Letter</b>	0-100g	1.58%	1.65%	1.38%	1.34%
	<b>Large Letter</b>	0-100g	2.37%	2.53%	2.15%	1.47%
	<b>Large Letter</b>	101-250g	1.70%	1.25%	1.85%	1.35%
	<b>Large Letter</b>	251-750g	1.65%	1.25%	1.85%	1.35%
<b>Economy</b>						
<b>Product Code</b>			<b>EBI</b>	<b>MXU</b>	<b>SPJ</b>	<b>SPJ</b>
	<b>Letter</b>	0-100g	1.57%	1.65%	1.36%	1.38%
	<b>Large Letter</b>	0-100g	2.37%	2.53%	2.16%	1.47%
	<b>Large Letter</b>	101-250g	1.67%	1.25%	1.85%	1.37%
	<b>Large Letter</b>	251-750g	1.65%	1.25%	1.85%	1.35%

Prices in this table exclude VAT, which is charged at the standard rate.

Prices in this table exclude the Mailing Standards Levy of 0.2% which is not subject to VAT.

Further details of the Mailing Standards Levy can be found in the specific terms relating to Advertising Mail.



**Table 2 – Intermediate Level pricing structure**

Delivery Speed	Format	Weight up to and including	Low Sort		High Sort	
			Mailmark	OCR	Direct	Residue
<b>1st Class</b>			<b>EBJ</b>	<b>MYK</b>	<b>SPF</b>	<b>SPF</b>
<b>Product Code</b>						
	<b>Letter</b>	0-100g	3.50%	3.50%	3.35%	3.35%
	<b>Large Letter</b>	0-100g	4.00%	4.50%	4.50%	3.50%
	<b>Large Letter</b>	101-250g	3.50%	2.50%	4.25%	2.80%
	<b>Large Letter</b>	251-750g	3.50%	2.50%	4.00%	2.50%
<b>2nd Class</b>			<b>EBK</b>	<b>MYL</b>	<b>SPH</b>	<b>SPH</b>
<b>Product Code</b>						
	<b>Letter</b>	0-100g	3.50%	3.50%	3.43%	3.48%
	<b>Large Letter</b>	0-100g	4.00%	4.50%	4.22%	3.83%
	<b>Large Letter</b>	101-250g	3.50%	2.50%	3.70%	2.35%
	<b>Large Letter</b>	251-750g	3.50%	2.50%	3.80%	2.30%
<b>Economy</b>			<b>EBL</b>	<b>MYM</b>	<b>SPK</b>	<b>SPK</b>
<b>Product Code</b>						
<b>Economy</b>	<b>Letter</b>	0-100g	3.50%	3.50%	3.42%	3.53%
	<b>Large Letter</b>	0-100g	4.00%	4.50%	4.21%	3.81%
	<b>Large Letter</b>	101-250g	3.50%	2.50%	3.80%	2.35%
	<b>Large Letter</b>	251-750g	3.50%	2.50%	3.80%	2.30%

Prices in this table exclude VAT, which is charged at the standard rate.  
 Prices in this table exclude the Mailing Standards Levy of 0.2% which is not subject to VAT.  
 Further details of the Mailing Standards Levy can be found in the specific terms relating to Advertising Mail.

Please note that Sustainable discounts should be applied to the relevant Advertising Mail price before the tray incentive is included

**Tray savings:** For trayed mailings of Letters you can save 0.30p (ex VAT) per item from the prices in this table.

**Tray savings:** For trayed mailings of Large Letters up to 10mm thick you can save 0.90p (ex VAT) per item from the prices in this table.

Prices exclude handling charges and VAT, which is charged at the standard rate. Subject to availability and a minimum charge of £500.

**Door to Door rate card (under 5mm in depth)**

Weight up to and including	Number of items per contract (price per 1,000 items)		
	Up to 25,000	25,001 – 100,000	100,001 – 200,000*
<b>20g</b>	£69.99	£63.68	£59.48
<b>35g</b>	£74.89	£68.14	£63.64
<b>60g</b>	£97.99	£89.15	£83.27
<b>80g</b>	£105.68	£96.16	£89.81
<b>100g</b>	£123.18	£112.08	£104.68
<b>120g</b>	£148.33	£133.02	£130.58
<b>140g</b>	£163.17	£146.33	£136.74
<b>160g</b>	£178.86	£160.41	£149.90
<b>180g</b>	£193.77	£173.76	£162.39
<b>200g</b>	£210.66	£188.92	£176.56

\*For standard rate card, distributions of over 200,000 items receive volume-related discounts. Each contract over this volume is priced according to the weight and geographic profile of the distribution and the Door to Door team will be able to provide you with an exact price for such distributions.

We also offer a New User rate for a new customer's first distribution.

**Door to Door rate card (under 5mm in depth)**

**New User**

Weight up to and including	Number of items per contract (price per 1,000 items)			
	Up to 25,000	25,001 – 100,000	100,001 – 200,000	200,000 – 500,000
<b>20g</b>	£62.99	£57.32	£53.53	£50.24
<b>35g</b>	£67.40	£61.33	£57.28	£53.76
<b>60g</b>	£88.19	£80.25	£74.94	£70.34
<b>80g</b>	£95.11	£86.55	£80.83	£75.86
<b>100g</b>	£110.86	£100.88	£94.21	£88.42

New offer rate applicable to brand new customers or customers returning after 18 months

Please remember, if your contracts contain items with a depth measuring 5mm or more, they must be booked through the Door to Door Booking Centre, please call **0345 266 0858**.

**Please note:** These are current prices and do not change on 2 January 2019.

# Door to Door

For any advice regarding Door to Door please call **0345 266 0858**, or visit: [royalmail.com/doortodoor](http://royalmail.com/doortodoor) for further information.

Please remember, if your contracts contain items with a depth measuring 5mm or more, they must be booked through the Door to Door Booking Centre.

We want to make your next leaflet campaign as easy to manage as possible. That's why we offer an end-to-end solution to suit your needs.

Our Booking Centre team can help you to plan, target and book your items, also help you with your print requirements and arrange collection and handover of your items to our processing centres.

There is a minimum charge per contract of £500 plus VAT. A contract can be booked for distributions over a 13 week period, and you can spread distribution and payments over this period to help reduce the upfront cost to you.

To discuss how Door to Door can help your business and to make a booking, please contact the Door to Door team between 8.30am and 5.30pm Monday to Friday on **0345 266 0858** or by email [doortodoor@royalmail.com](mailto:doortodoor@royalmail.com)

You can also visit [royalmail.com/doortodoor](http://royalmail.com/doortodoor) for more information.

# Business Mail

## Standard unsorted options

### Letter

Delivery Speed	Option	Product Code	Weight up to and including	Number of items per sales order <sup>†</sup>				
				1-999	1,000-2,499	2,500-9,999	10,000-24,999	25,000+
1st Class	Standard	STL	100g	63.0p	60.9p	59.6p	58.3p	57.0p
	Account <sup>††</sup>	UNA	100g	59.5p	57.5p	56.3p	55.1p	53.8p
2nd Class	Standard	STL	100g	42.7p	41.7p	40.8p	39.8p	39.0p
	Account <sup>††</sup>	UNB	100g	40.0p	39.1p	38.2p	37.3p	36.5p

Prices in this table exclude VAT, which is charged at the standard rate.

<sup>†</sup>In order to qualify for a price based on number of items, items must be of the same service, class and format, and be contained on a single sales order.

<sup>††</sup>Barcode savings. A barcode is required for the Account options. For further information visit [royalmail.com/barcodesavings](http://royalmail.com/barcodesavings)

## Highly Machine readable unsorted options

### Letter

Delivery Speed	Product Code	Option	Weight up to and including	Number of items per sales order <sup>†</sup>						
				1-249	250-499	500-999*	1,000-2,499	2,500-9,999	10,000-24,999	25,000+
1st Class	UNI	Advanced	100g	59.5p	49.9p	49.9p	49.1p	48.1p	47.1p	46.0p
	EBR	Mailmark	100g	59.5p	59.5p	48.7p	47.8p	46.8p	45.8p	44.8p
	CL3	OCR	100g	n/a	n/a	51.8p	50.9p	49.8p	48.7p	47.7p
2nd Class	UNJ	Advanced	100g	40.0p	32.8p	32.8p	32.2p	31.6p	30.9p	30.2p
	EBS	Mailmark	100g	40.0p	40.0p	31.3p	30.7p	30.1p	29.4p	28.8p
	CL4	OCR	100g	n/a	n/a	33.0p	32.4p	31.7p	31.1p	30.4p

Prices in this table exclude VAT, which is charged at the standard rate.

<sup>†</sup>In order to qualify for a price based on number of items, items must be of the same service, class and format, and be contained on a single sales order. Mailings of less than the minimum volumes may be refused or charged at a higher price.

#### For Business Mail Advanced (BMA) posted via Mailmark Franking machines:

(New process for mail pieces without a 12 alpha character licence that do not require an OBA Sales Order)

Prices franked per item: Business Mail Advanced 1st Class 60p  
Business Mail Advanced 2nd Class 40p

All credit or debit will be automatically applied to your account with your franking machine supplier. You will receive a VAT statement and Franking Account statement monthly.

#### For Business Mail Advanced (BMA) posted via Smartmeter and Mailmark Franking machines:

(For mail pieces with a 12 alpha character licence that require use of an OBA Sales Order)

Prices franked per item: Business Mail Advanced 1st Class 72p  
Business Mail Advanced 2nd Class 54p

These higher control prices are before the BMA discount has been awarded. Discounted BMA prices are shown in the Business Mail rate card.

#### All BMA franking customers

BMA items which do not qualify will be charged at 59.5p (exc VAT) for 1st Class, and 40p (exc VAT) for 2nd Class. Note all BMA prices are subject to VAT.

For users of Mailmark franking technology, the most up to date and best value franking tariff is always in your mailmark machine.

# Business Mail

## Low Sort and High Sort options

### Letter

Delivery Speed	Option	Product Code	Weight up to and including	Number of items per day*				
				4,000-19,999	20,000-39,999	40,000-79,999	80,000-119,999	120,000+
<b>1st Class</b>	Low-Sort Mailmark	EBA	100g	45.3p	44.4p	43.2p	42.6p	42.2p
	Low-Sort OCR	MXD	100g	47.2p	46.3p	45.1p	44.5p	44.1p
	High Sort Direct	LE1	100g	56.0p	55.0p	53.8p	53.2p	52.7p
	High Sort Residue*	LE1	100g	57.5p	56.5p	56.2p	55.9p	55.6p
<b>2nd Class</b>	Low-Sort Mailmark	EBB	100g	31.8p	31.2p	30.3p	29.9p	29.6p
	Low-Sort OCR	MXE	100g	33.2p	32.5p	31.7p	31.3p	31.0p
	High Sort Direct	LE2	100g	38.8p	38.2p	37.3p	36.9p	36.6p
	High Sort Residue*	LE2	100g	39.9p	39.2p	39.0p	38.8p	38.6p
<b>Economy</b>	Low-Sort Mailmark	EBC	100g	28.8p	28.3p	27.5p	27.2p	26.9p
	Low-Sort OCR	MXF	100g	30.2p	29.6p	28.8p	28.5p	28.2p
	High Sort Direct	LE3	100g	32.7p	32.1p	31.4p	31.1p	30.8p
	High Sort Residue*	LE3	100g	33.5p	33.2p	33.0p	32.9p	32.8p

Large Letters between 250g and 750g are priced per gram.  
For details see the **Business Mail rate card**.

Prices in this table exclude VAT, which is charged at the standard rate.

\*The price for Residue is based on the number of items per mailing, not per day.

Mailings of less than 4,000 items may be refused or charged at a higher rate.

**Tray savings:** For trayed mailings of Letters you can save 0.30p (ex VAT) per item from the prices in this table.

# Business Mail

## Standard unsorted options

### Large Letter

Delivery Speed	Option	Product Code	Weight up to and including	Number of items per sales order†				
				1-249	250-749	750-1,999	2,000-4,999	5,000+
<b>1st Class</b>	Standard	STL	100g	96.2p	94.7p	93.2p	91.2p	89.3p
			250g	133.0p	130.9p	128.9p	126.2p	123.4p
			500g	169.0p	166.4p	163.8p	160.3p	156.8p
			750g	237.0p	233.3p	229.7p	224.8p	219.9p
	Account††	UNA	100g	94.0p	92.5p	91.1p	89.2p	87.2p
			250g	130.0p	128.0p	126.0p	123.3p	120.6p
			500g	165.0p	162.4p	159.9p	156.5p	153.1p
			750g	233.0p	229.4p	225.8p	221.0p	216.2p
<b>2nd Class</b>	Standard	STL	100g	74.8p	73.6p	72.0p	70.3p	68.8p
			250g	105.0p	103.3p	101.1p	98.8p	96.5p
			500g	131.0p	128.8p	126.2p	123.2p	120.5p
			750g	184.0p	181.0p	177.2p	173.1p	169.2p
	Account††	UNB	100g	72.0p	70.8p	69.3p	67.7p	66.2p
			250g	102.0p	100.3p	98.2p	95.9p	93.8p
			500g	129.0p	126.9p	124.2p	121.3p	118.6p
			750g	183.0p	180.0p	176.2p	172.1p	168.3p

Prices in this table exclude VAT, which is charged at the standard rate.

†In order to qualify for a price based on number of items, items must be of the same service, class and format, and be contained on a single sales order.

††Barcode savings. A barcode is required for the Account options. For further information visit [royalmail.com/barcodesavings](http://royalmail.com/barcodesavings)

# Business Mail

## Highly machinable unsorted options

### Large Letter

Delivery Speed	Option	Product Code	Weight up to and including	Number of items per sales order				
				1-249	250-749	750-1,999	2,000-4,999	5,000+
1st Class	Mailmark	EBR	100g	94.0p	81.1p	79.3p	77.6p	75.9p
			250g	130.0p	112.1p	109.6p	107.4p	105.0p
			500g	173.0p	149.2p	145.9p	142.9p	139.7p
			750g	245.0p	211.3p	206.6p	202.3p	197.8p
	Advanced	UNI	100g	94.0p	84.3p	82.3p	80.7p	78.8p
			250g	130.0p	116.5p	113.9p	111.6p	109.0p
			500g	168.0p	150.6p	147.2p	144.2p	140.9p
			750g	236.0p	211.6p	206.7p	202.6p	197.9p
	OCR	CL3	100g	n/a	85.5p	83.6p	81.9p	80.0p
			250g	n/a	121.8p	119.2p	116.7p	114.1p
			500g	n/a	158.2p	154.7p	151.5p	148.1p
			750g	n/a	224.0p	219.1p	214.5p	209.8p
2nd Class	Mailmark	EBS	100g	72.0p	64.8p	63.4p	62.1p	60.7p
			250g	102.0p	91.9p	89.9p	88.0p	86.0p
			500g	134.0p	120.7p	118.0p	115.6p	113.0p
			750g	190.0p	171.1p	167.4p	163.9p	160.2p
	Advanced	UNJ	100g	72.0p	66.6p	65.2p	63.8p	62.7p
			250g	102.0p	94.4p	92.4p	90.4p	88.9p
			500g	131.0p	121.2p	118.7p	116.1p	114.2p
			750g	186.0p	172.1p	168.5p	164.8p	162.1p
	OCR	CL4	100g	n/a	67.8p	66.3p	64.9p	63.5p
			250g	n/a	97.8p	95.6p	93.6p	91.5p
			500g	n/a	128.7p	125.9p	123.3p	120.5p
			750g	n/a	182.7p	178.7p	175.0p	171.1p

Prices in this table exclude VAT, which is charged at the standard rate.

<sup>1</sup>In order to qualify for a price based on number of items, items must be of the same service, class and format, and be contained on a single sales order.

Mailings of less than the minimum volume may be refused or charged at a higher price.

# Business Mail

## Sorted options

### Large Letter

Delivery Speed	Option	Product Code	Weight up to and including	Number of items per day <sup>1</sup>					
				1,000-9,999	10,000-19,999	20,000-39,999	40,000-59,999	60,000+	
1st Class	Low-Sort Mailmark	EBA	100g	63.8p	62.7p	61.2p	60.5p	59.9p	
			250g	71.9p	70.7p	69.0p	68.2p	67.5p	
	Low-Sort OCR	MXD	100g	67.3p	66.6p	66.2p	65.8p	65.0p	
			250g	76.3p	75.5p	75.1p	74.6p	73.8p	
	High Sort Direct	LE1	100g	66.2p	65.1p	63.6p	62.8p	62.2p	
			250g	74.8p	73.5p	71.8p	71.0p	70.3p	
	High Sort Residue*	LE1	100g	73.9p	72.8p	72.0p	72.0p	71.6p	
			250g	83.4p	82.1p	81.3p	81.3p	80.8p	
	2nd Class	Low-Sort Mailmark	EBB	100g	45.7p	44.9p	43.9p	43.3p	42.9p
				250g	59.3p	58.2p	56.8p	56.2p	55.6p
		Low-Sort OCR	MXE	100g	48.1p	47.6p	47.3p	47.0p	46.5p
				250g	62.6p	61.9p	61.6p	61.2p	60.5p
High Sort Direct		LE2	100g	47.5p	46.7p	45.6p	45.1p	44.6p	
			250g	61.6p	60.6p	59.1p	58.4p	57.9p	
High Sort Residue*		LE2	100g	53.0p	52.1p	51.6p	51.6p	51.3p	
			250g	68.7p	67.6p	66.9p	66.9p	66.6p	
Economy		Low-Sort Mailmark	EBC	100g	40.9p	40.2p	39.3p	38.8p	38.5p
				250g	52.7p	51.8p	50.6p	50.0p	49.5p
		Low-Sort OCR	MXF	100g	43.1p	42.6p	42.4p	42.1p	41.7p
				250g	55.7p	55.1p	54.8p	54.5p	53.9p
	High Sort Direct	LE3	100g	42.5p	41.8p	40.8p	40.3p	39.9p	
			250g	54.6p	53.7p	52.4p	51.8p	51.3p	
High Sort Residue*	LE3	100g	47.4p	46.9p	46.7p	46.4p	46.4p		
250g	60.9p	60.3p	60.0p	59.7p	59.7p				

Large Letters between 250g and 750g are priced per gram.  
For details see the **Business Mail rate card**.

Prices in this table exclude VAT, which is charged at the standard rate.

\*The price for Residue is based on the number of items per mailing, not per day.

**Tray savings:** For trayed mailings of Large Letters up to 10mm thick you can save 0.90p (ex VAT) per item from the prices in this table.

## Publishing Mail

You may qualify for a special rate if you have a high proportion of city centre addresses on your database.

To find out more go to [royalmail.com/publishing-mail](http://royalmail.com/publishing-mail)

### Low Sort and High Sort options

#### Large Letter

Delivery Speed	Option	Product Code	Weight up to and including	Number of items per day*				
				1,000-9,999	10,000-19,999	20,000-39,999	40,000-59,999	60,000+
1st Class	Low-Sort Mailmark	EBP	100g	56.7p	56.1p	55.1p	54.1p	53.8p
			250g	62.5p	61.8p	60.8p	59.7p	59.4p
	Low-Sort OCR	PQ3	100g	59.8p	59.1p	58.8p	58.5p	57.8p
			250g	66.0p	65.2p	64.9p	64.5p	63.8p
	High Sort Direct	PR1	100g	58.9p	58.2p	57.2p	56.2p	55.9p
			250g	64.7p	63.9p	62.9p	61.8p	61.4p
	High Sort Residue*	PR1	100g	64.0p	63.4p	63.0p	62.7p	62.0p
			250g	70.1p	69.4p	69.0p	68.6p	67.9p
2nd Class	Low-Sort Mailmark	EBQ	100g	41.0p	40.5p	39.8p	39.2p	38.9p
			250g	52.2p	51.6p	50.7p	49.9p	49.6p
	Low-Sort OCR	PQ4	100g	43.3p	42.8p	42.6p	42.4p	41.9p
			250g	55.0p	54.4p	54.1p	53.8p	53.2p
	High Sort Direct	PR2	100g	42.6p	42.2p	41.4p	40.7p	40.5p
			250g	54.4p	53.7p	52.8p	51.9p	51.6p
	High Sort Residue*	PR2	100g	46.0p	45.5p	45.3p	45.1p	44.6p
			250g	59.1p	58.5p	58.2p	57.9p	57.3p

For details of Large Letters between 250g and 750g and Parcels see the **Publishing Mail rate card**.

Prices in this table exclude VAT, which is charged at the standard rate.

\*The price for Residue is based on the number of items per mailing, not per day.

Premium – enables you to have later access to our network. For more information go to

[royalmail.com/publishing-mail](http://royalmail.com/publishing-mail)

**Tray savings:** For trayed mailings of Large Letters up to 10mm thick you can save 0.90p (ex VAT) per item from the prices in this table.

## Subscription Mail

### Low Sort options

#### Large Letter

Delivery Speed	Option	Product Code	Weight up to and including	Number of items per day*				
				2,000-9,999	10,000-19,999	20,000-39,999	40,000-59,999	60,000+
1st Class	Low-Sort Mailmark	PQC	100g	55.1p	54.5p	53.6p	52.7p	52.4p
			250g	60.5p	59.8p	58.8p	57.8p	57.5p
2nd Class	Low-Sort Mailmark	PQD	100g	39.5p	39.0p	38.4p	37.7p	37.5p
			250g	50.2p	49.6p	48.8p	48.0p	47.7p

\*Mailings of less than 2,000 items may be charged at a higher rate.

\*\*Mailings of new titles with a minimum of 1,000 items are permitted in the first year.

**Tray savings:** For trayed mailings of Large Letters up to 10mm thick you can save 0.90p (ex VAT) per item from the prices in this table.

# Response Services

## Business Reply and Freepost

Business Reply and Freepost enable your customers to respond easily and cost free to your outbound communications.

To get our lowest price simply provide your customers with a pre printed, machine readable envelope, typically used for many financial transactions and customer orders. This is our **PLUS** option and is available for letter format only.

If you want the flexibility of different sizes and weights to come back, then our **STANDARD** service covers all options.

Finally, if you want your customers to provide the envelope, and simply handwrite the return address, then **FREEPOST NAME** is ideal, as they only need to remember the name, not a postal address. Great if you are using broadcast media or off the page.

To get more detail on any of these options please visit [royalmail.com/responseservices](http://royalmail.com/responseservices)

### Business Reply Plus & Freepost Plus

Format	Weight up to and including	1st Class	2nd Class
Letter*	100g	51.5p	37.5p

Prices in this table exclude VAT, which is charged at the standard rate.

\*Only Letter format items can be sent using Business Reply Plus and Freepost Plus.

### Letter and Large Letters

Format	Business Reply Standard & Freepost Standard		Freepost NAME
	Weight up to and including	1st Class	1st Class
Letter	100g	58.0p	59.0p
Large Letter	100g	79.0p	88.0p
	250g	113.0p	122.0p
	500g	152.0p	161.0p
	750g	220.0p	229.0p

Prices in this table exclude VAT, which is charged at the standard rate.

Note: The Business Reply Standard and Freepost Standard prices above apply to alpha, alpha numeric and licence barcode styles.

# Response Services

## Business Reply and Freepost

### Parcels\*

Format	Business Reply Standard & Freepost Standard		Freepost NAME
	Weight up to and including	1st Class	1st Class
Parcels	0-1000g	£3.94	£4.05
	1250g	£5.96	£6.05
	1500g	£6.72	£6.80
	1750g	£7.76	£7.85
	2000g	£8.28	£8.38
	4000g	£11.37	£11.46
	4000-6000g	£15.22	£15.31
For each additional 2000g or part thereof add			£3.85

Prices in this table exclude VAT, which is charged at the standard rate.

Note: The Business Reply Standard and Freepost Standard prices above apply to alpha, alpha numeric and licence barcode styles.

\*Prices effective from 26 March 2017.

**Licence Fees** – to use any of our Response Services, you'll need to sign up for the appropriate annual licence. Once you've signed up you'll only pay postage for the replies you receive.

Service	Annual Licence Fee
Business Reply Plus, Freepost Plus, Business Reply Standard and Freepost Standard Response Plus > 10 licences	£99
Freepost NAME (first licence)	£55
Freepost NAME (subsequent licences)	£224
Royal Mail Special Delivery Guaranteed with Response	£120
	£135

Prices in this table exclude VAT, which is charged at the standard rate.

Please note that a deposit may be required.

**Admail** – is our redirection service for direct response advertisers, enabling you to receive orders and enquiries at a different address from the one used in your promotional material or advertising.

Duration	Price
30 days	£199
60 days	£316
90 days	£410
180 days	£690
1 year	£999

Prices in this table exclude VAT, which is charged at the standard rate.

## Inbound Mail Services

**Selectapost** – saves you time by delivering mail already sorted by up to 25 departments or categories.

The right choice for your business if you:

- need to have mail on desks in the quickest possible time
- need us to deliver your mail already sorted into as many as 25 categories that you specify, such as departments or your floors.

To find out more go to [royalmail.com/selectapost](http://royalmail.com/selectapost)

	Price	Price
	If delivered to a single point	If delivered to multiple points
<b>Fixed Annual charge per selection*</b>	£174	£174
<b>per 1000 Letters</b>	£28	£29
<b>per 1000 Large Letters</b>	£42	£43

Prices in this table exclude VAT, which is charged at the standard rate.

\*Annual charge is invoiced quarterly.

**Pre-sorted Delivery** – if you receive on average 6,000 items or more daily, or need more than 25 departments, Pre-sorted Delivery saves you time by delivering mail already sorted.

The right choice for your business if you:

- want us to sort your company's incoming mail before it's delivered, saving you time and freeing up space
- would like the choice of having your mail sorted to more than 25 departments or categories
- are looking for savings efficiency.

If you would like a quote go to [royalmail.com/psd](http://royalmail.com/psd)

**Early Collect** – enables you to collect your mail at an earlier time that suits you.

The right choice for your business if you:

- want to respond to your customers at the earliest opportunity
- need the convenience of picking up mail from your local delivery office before office hours, 6.00am until 8.30am, Monday to Saturday.

For more information go to [royalmail.com/earlycollect](http://royalmail.com/earlycollect)

**Early Extraction** – enables you to access your mail at the earliest possible time in the morning.

The right choice for your business if you:

- want to access your mail ahead of normal delivery time – and as early as you need
- would like the chance to process incoming mail sooner
- want the flexibility of a six days a week service.

If you would like a quote go to [royalmail.com/earlyextraction](http://royalmail.com/earlyextraction)

## Adjustment Charges

### Mailmark Adjustment Charges

Fault	Applies to	Flat Fee	Per Item Fee	Notes
<b>Missorts</b>	Mailmark Letters	n/a	13.95p	
<b>Missorts</b>	Mailmark Large Letters	n/a	38.75p	
<b>International item as domestic</b>	Mailmark	n/a	£1.56	Adjustment charges only apply when one or a combination of charges result in a charge of £10 or more per eManifest
<b>Non machine processed</b>	Mailmark Letters	n/a	2.04p	
<b>Non machine processed</b>	Mailmark Large Letters	n/a	3.64p	Postcode and Delivery point suffix accuracy adjustment charges only apply if the combined result drops below 90% per eManifest
<b>Postcode accuracy</b>	Mailmark Letters	n/a	8.05p	
<b>Postcode accuracy</b>	Mailmark Large Letters	n/a	15.78p	
<b>Delivery point suffix accuracy</b>	Mailmark Letters and Large Letters	n/a	0.86p	
<b>Missing or incorrect eManifest ID</b>	Mailmark Letters and Large Letters	£27.23	n/a	per eManifest
<b>Unmanifested volume and Duplicates</b>	Mailmark Letters and Large Letters	£27.23	0.46p Letters/0.73p Large Letters	per supply chain
<b>Incorrect SCID</b>	Mailmark Letters and Large Letters	£27.23	n/a	per eManifest
<b>Item ID mismatch</b>	Mailmark Letters and Large Letters	£27.23	n/a	per eManifest

### Account and Advanced Charges

Fault	Applies to	Class	Format	Flat Fee	Per Item Fee
<b>Barcode not seen</b>	Unsorted Account	1st Class and 2nd Class	Letters and Large Letters	n/a	3p
<b>Sales Order Under Declared – UK</b>	Account and Advanced	1st Class 2nd Class 1st Class 2nd Class	Letters Letters Large Letters Large Letters	n/a	59.5p 40p £1.30 £1.02
<b>Sales Order Under Declared – International</b>	Account and Advanced Ls and LLs		Letters and Large Letters	n/a	£1.62L/£3.96LL
<b>Not highly machinable</b>	Advanced	1st Class 2nd Class 1st Class 2nd Class	Letters Letters Large Letters Large Letters	n/a	9.6p 7.2p 2.0p 1.5p
<b>Not highly machinable</b>	Local	1st Class 2nd Class 1st Class 2nd Class	Letters Letters Large Letters Large Letters	n/a	10.1p 7.7p 8.4p 6.1p
<b>Missing Sales Order</b>	Mailmark			£27.23	n/a
<b>Incorrect Sales Order</b>	Mailmark			£27.23	n/a

Prices in these tables exclude VAT, which is charged at the standard rate.

Full details of the Mailmark adjustment framework are available at [royalmail.com/mailmark](http://royalmail.com/mailmark)

\*The total amount charged for these faults will not exceed the price of the next available service.

\*\*The difference in price between the volume declared versus the volume submitted.

# Adjustment Charges

## Machine Readable Adjustment Charges

Fault	Applies to	Flat Fee	Per item fee	Note
Low volume faults	Sorted machine-readable	£27.23	n/a	per posting
Medium volume low impact faults	Sorted machine-readable	£27.23	n/a	per posting
Medium volume high impact faults	Sorted machine-readable	£27.23	adjustment	10% of posting adjusted
High volume low impact faults	Sorted and non-sorted machine-readable	£27.23	n/a	per posting
High volume high impact faults	Sorted	£27.23	adjustment	100% of mailing adjusted
Incorrect licence design	BMA on account and Response Services	£27.23	n/a	per month

Prices in this table exclude VAT, which is charged at the standard rate.

\*Fee applies to sorted machine-readable mail only.

Full details of the Low/High machine readable faults are available in the Quick Guides at [royalmailtechnical.com](http://royalmailtechnical.com)

## Other Adjustment Charges

Fault	Applies to	Flat Fee	Per item fee	Notes
Presentation errors	Sorted	£27.23	n/a	per posting
Incorrect labels/bag ties	Sorted	£27.23	20p	per label or tie
Incorrect cage cards	Sorted	£27.23	25p	per card used
Storage costs	Sorted	£27.23	25p	per cage per day
Overweight bags/bundles/trays	Sorted	£27.23	65p	per bag/bundle/tray generated
Overweight Cages/Yorks	Sorted	£27.23	65p	per Cage/York generated
Minimum average items per selection	Sorted	£27.23	adjustment	100% of mailing
Bulk surcharging	Unsorted	n/a	33p	per item
Response specification	Response Services	n/a	33p	per item
Missing sales order	All products	£27.23	n/a	per posting
Incorrect sales order	All products	£27.23	n/a	per posting

Prices in this table exclude VAT, which is charged at the standard rate, except for Bulk surcharges.

\*Bulk surcharges are exempt from VAT.

# Contact

We hope that this tariff guide has been useful, but should you need any further help or advice, please do contact your Account Manager, or the customer helpline: **08457 950 950\***

or through our website:  
**[royalmail.com/contact](http://royalmail.com/contact)**

## Alternative formats

If it would help you to have this booklet in a different format, we can provide it free of charge as:

A large print booklet      An audio tape  
An audio CD                      A Braille booklet

Simply call us on **08457 950 950\***.

If you are deaf or hearing impaired, we offer a textphone service on **03456 000 606**.

\*Calls cost 5p per minute plus your telephone company's network access charge.

Royal Mail, the Cruciform all marks indicated with ® are registered trade marks of Royal Mail Group Ltd. Marketing Services Price guide 2019 © Royal Mail Group 2019. All rights reserved. Royal Mail is a trading name of Royal Mail Group Ltd, registered in England and Wales number 4138203. Registered office 100 Victoria Embankment, LONDON, EC4Y 0HQ.



